



Ortho Innovations.

PAKISTAN

ORTHON CERVICAL SPINAL LOCKING PLATE. CSLP



CSLP Small Stature



CSLP Variable Angle



CSLP



CSLP VARIABLE ANGLE

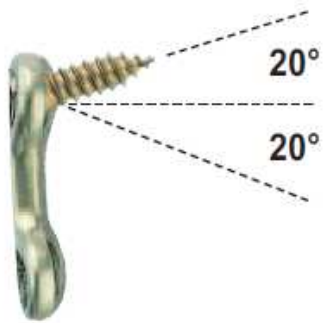

The CSLP Variable Angle is designed to ease the surgical technique and increase system versatility, while maintaining the mechanical properties of the existing Cervical Spine Locking Plate.



1 Level

CSLP-1A



2 Level

CSLP-2A



3 Level

CSLP-3A



4 Level

CSLP-4A



Plate Comparisons

General Specifications	CSLP Variable Angle	CSLP Small Stature	Cervical Spine Locking Plate
Plate Color	Light Green	Light Blue	Gold
Plate Width	18 mm	16 mm	21 mm
Axial Bend Radius	20 mm	15 mm	25 mm
Pre-Bent Lordotic Radius	200 mm	NA	NA
Maximum Thickness	2.5 mm	2.0 mm	2.0 mm
Lengths Available (overall)			
1-Level	23 mm–35 mm	20 mm–34 mm	22 mm–34 mm
2-Level	37 mm–55 mm	34 mm–54 mm	36 mm–54 mm
3-Level	54 mm–78 mm	47 mm–77 mm	53 mm–77 mm
4-Level	69 mm–109 mm	NA	68 mm–92 mm
Screw Angulation			
Cephalad Pair	Up to 20°	6° cephalad	12° cephalad
Intermediate Pairs	Up to 20°	0°	0°



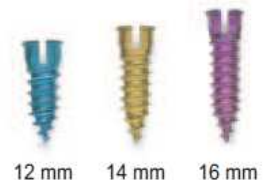

Self-Drilling Screws

Self-drilling screws make drilling unnecessary. They have the same pull-out strength as self-tapping and standard screws of the same size.





Expansionhead Screws Compatible with CSLP Variable Angle

		12 mm	14 mm	16 mm	18 mm	19 mm	20 mm
Standard Screws	4.0 mm Cortex	•	•	•			
	4.35 mm Cancellous	•	•	•			
							
Self-Tapping Screws	4.0 mm Cortex	•	•	•	•	•	•
	4.0 mm Cancellous	•	•	•			
	4.35 mm Cancellous	•	•	•			
	4.5 mm Cancellous	•	•	•			
							
Self-Drilling Screws	4.0 mm Cortex	•	•	•	•	•	•
	4.0 mm Cancellous	•	•	•			
	4.5 mm Cancellous	•	•	•			
							

• Recommended for use Not available



Additional Features

- Pre-lordosed plates
- Back surface of plate textured to reduce slippage
- Longer screw lengths allow bicortical screw purchase
- Available for 1-, 2-, 3- and 4-level corpectomies and discectomies



*Bicortical screws (green)
18 mm, 19 mm, 20 mm*

SCREWS

STANDARD

DIAMETER	12MM	14MM	16MM	18MM	19MM	20MM
4.0 CORTEX	CSLS-001	CSLS-002	CSLS-003			
4.35 CANCELLOUS	CSLS-101	CSLS-102	CSLS-103			

SELF TAPPING

4.0 CORETX	CSLS-201	CSLS-202	CSLS-203	CSLS-204	CSLS-205	CSLS-206
4.0 CANCELLOUS	CSLS-301	CSLS-302	CSLS-303			
4.35 CANCELLOUS	CSLS-401	CSLS-402	CSLS-403			
4.5 CANCELLOUS	CSLS-501	CSLS-502	CSLS-503			

SELF DRILLING

4.0 CORETX	CSLS-601	CSLS-602	CSLS-603	CSLS-604	CSLS-605	CSLS-606
4.0 CANCELLOUS	CSLS-701	CSLS-702	CSLS-703			
4.35 CANCELLOUS	CSLS-801	CSLS-802	CSLS-803			
4.5 CANCELLOUS	CSLS-901	CSLS-902	CSLS-903			

4.0 BICORTICAL

	CSLS-001A	CSLS-002A	CSLS-003A
--	-----------	-----------	-----------



CSLP Small Stature

Small Stature CSLP is designed for small vertebral bodies. It has the narrowest plate width of all CSLP versions, without compromising stiffness and strength.

Features

- 16 mm plate width
- 2 mm plate thickness
- Available for 1-, 2- or 3-level corpectomies or discectomies

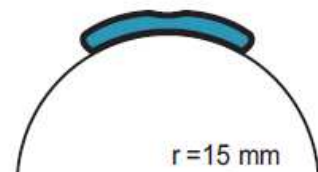

1 Level
CSLLP-1B



2 Level
CSLP-2B



3 Level
CSLP-3B

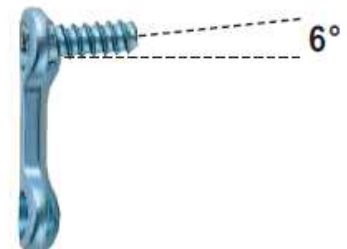



Expansionhead Screws Compatible with CSLP Small Stature

		12 mm	14 mm	16 mm	18 mm	19 mm	20 mm
Standard Screws	4.0 mm Cortex	•	•				
	4.35 mm Cancellous	•	•				
Self-Tapping Screws	4.0 mm Cortex	•	•				
	4.0 mm Cancellous	•	•				
	4.35 mm Cancellous	•	•				
	4.5 mm Cancellous	•	•				
Self-Drilling Screws	4.0 mm Cortex						
	4.0 mm Cancellous						
	4.5 mm Cancellous						

• Recommended for use Not recommended for use Not available



CSLP

Introduced in 1991, the CSLP was the first unicortical anterior cervical plate system. Its clinical success has been documented in over 20 peer-reviewed studies.¹⁰

Features

- 21 mm plate width
- 2.0 mm plate thickness
- Cloverleaf hole configuration for graft screws
- Available for 1-, 2-, 3- and 4-level corpectomies and discectomies

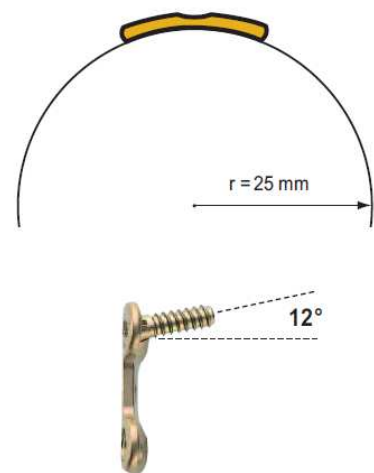
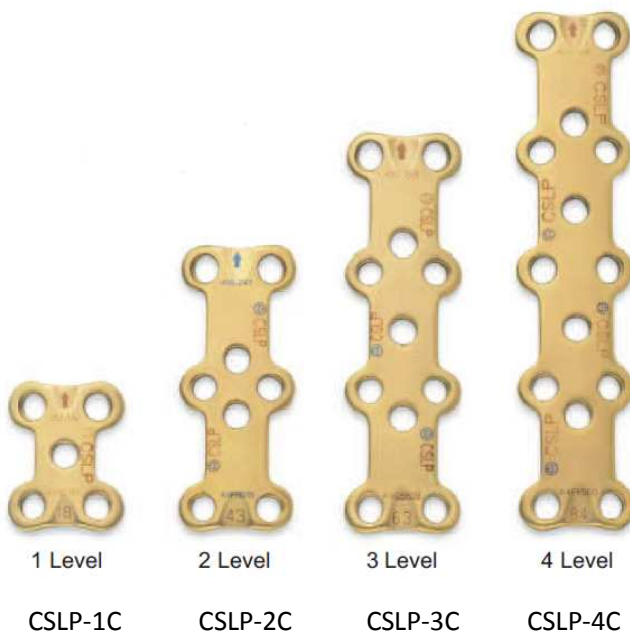



Ortho Innovations.

PAKISTAN

Expansionhead Screws Compatible with CSLP

		12 mm	14 mm	16 mm	18 mm	19 mm	20 mm
Standard Screws	4.0 mm Cortex	•	•	•			
	4.35 mm Cancellous	•	•	•			
Self-Tapping Screws	4.0 mm Cortex	•	•	•			
	4.0 mm Cancellous	•	•	•			
	4.35 mm Cancellous	•	•	•			
	4.5 mm Cancellous	•	•	•			
Self-Drilling Screws	4.0 mm Cortex						
	4.0 mm Cancellous						
	4.5 mm Cancellous						

• Recommended for use ■ Not recommended for use ■ Not available



Ortho Innovations.

PAKISTAN

INSTRUMENTS

LOCKING DRILL GUIDE

CSLP-001

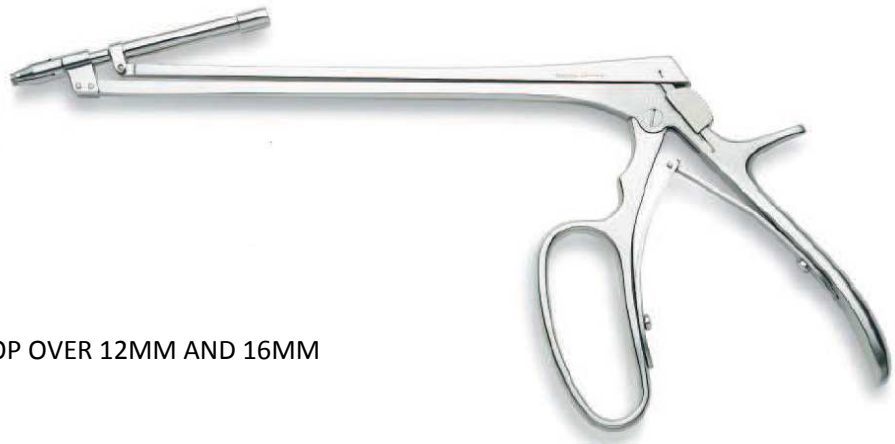

DRILL BIT 3.0MM WITH STOP OVER 12MM AND 16MM

CSLP-002



OWL FOR SELF DRILLING SCREWS

CSLP-003



TIP OF OWL



Ortho Innovations.

PAKISTAN

CERVICAL DEPTH GAUGE

CSLP-004



3.9MM DRILL BIT FOR BIOCORTICAL SCREWS

CSLP-005



CALIPER

CSLP-006

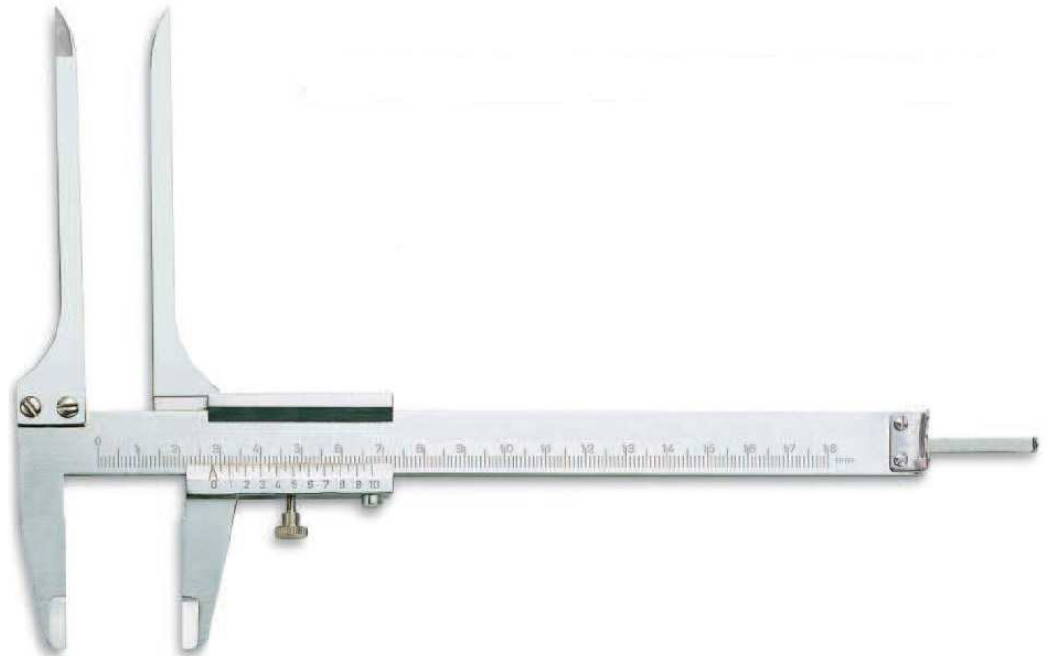



Ortho Innovations.

PAKISTAN

COUNTER TORQUE WRENCH

CSLP-007



TEMPORARY FIXATION PIN

CSLP-008



TAP

CSLP-009



SCREW DRIVER FOR EXPANSION HEAD SCREWS

CSLP-010





Ortho Innovations.

PAKISTAN

SCREW DRIVER FOR LOCKING SCREWS

CSLP-011



PLATE LIFTER

CSLP-012



QUICK COUPLING HANDLE

CSLP-013





Ortho Innovations.

PAKISTAN

PLATE BENDER

CSLP-014



CONICAL EXTRACTION SCREW

CSLP-015





Ortho Innovations.

PAKISTAN

CERVICAL PLATE HOLDER

CSLP-016

